



# **BRITISH HOT TUBS**

**BHT T500ST+HT  
SWIM SPA**

# Introducing the British Swim Spa range - proudly designed in the UK.



*An appreciation for heritage without being defined by it, quirky, stylish and fun.*

Our amazing range of Swim Spas has been designed exclusively for you and your family. You can choose every zone of your Swim Spa to personalise the perfect aquatic exercise experience.

Exclusively designed in the UK – specifically for our precious customers, and our inclement climate, our exclusive Swim Spa range offers more exercise options, is energy efficient, environmentally friendly and above all – our Award Winning swim spas are the best in the industry

With the addition of the unrivalled Turbine technology, you can benefit from a true swimming experience that can be personalised to suit you!

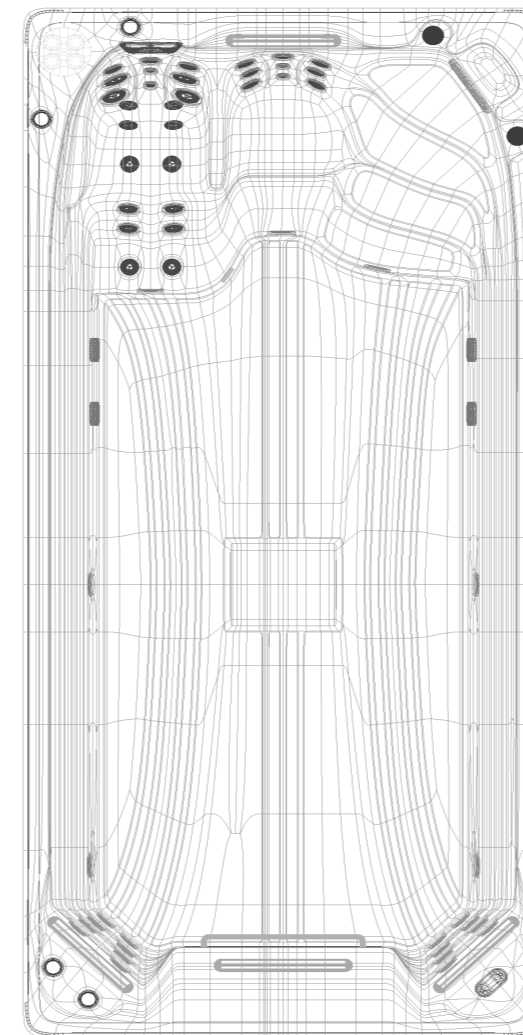

**PROUDLY DESIGNED IN THE UK**

We have invested 12 months and a huge budget in creating the right partnership, the right designs and the right processes - this is important to us to ensure that our customers will buy a product that is reliable, safe and energy efficient.

Our range of 13 hot tubs feature the very best available innovations and North American parts and components.

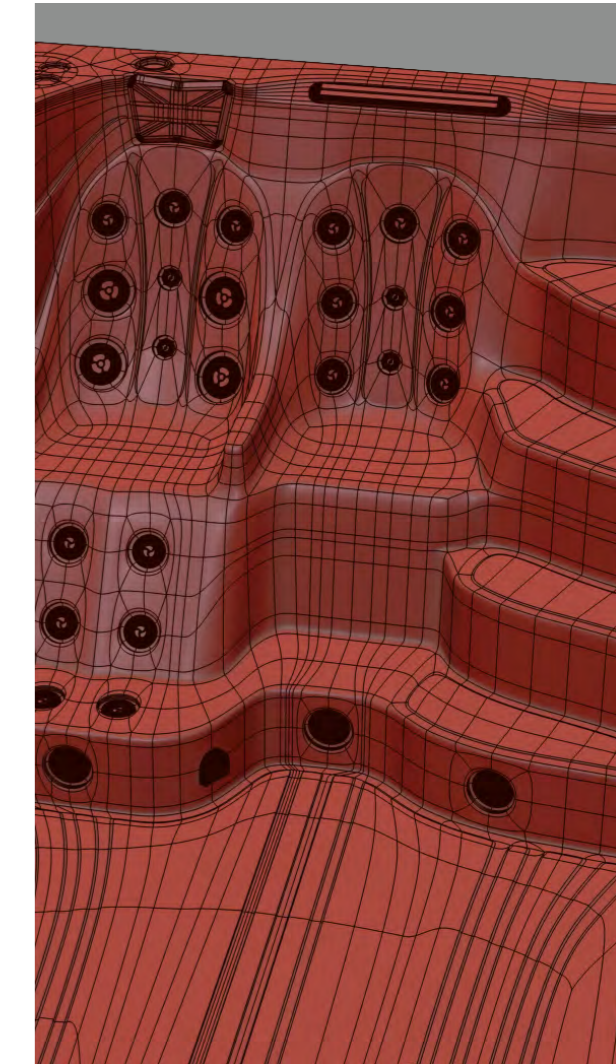

## T500ST+HT SEATING

## SWIM SPA SPECIFICATION

<b>DIMENSIONS:</b>	805 x 225 x 152 CM
<b>WATER CAPACITY:</b>	Approx. 10,260L
<b>WEIGHT:</b>	1,520KG
<b>SWIM JETS:</b>	3 x High Flow River Jets
<b>LIGHTING:</b>	Underwater Lighting
<b>PUMPS:</b>	3 x 3HP + 1 x 2HP 1 x Circulation Pump 1HP
<b>JETS:</b>	43 (40 Hydrotherapy / 3 Swim)
<b>CONTROLLER:</b>	Balboa Touch Screen

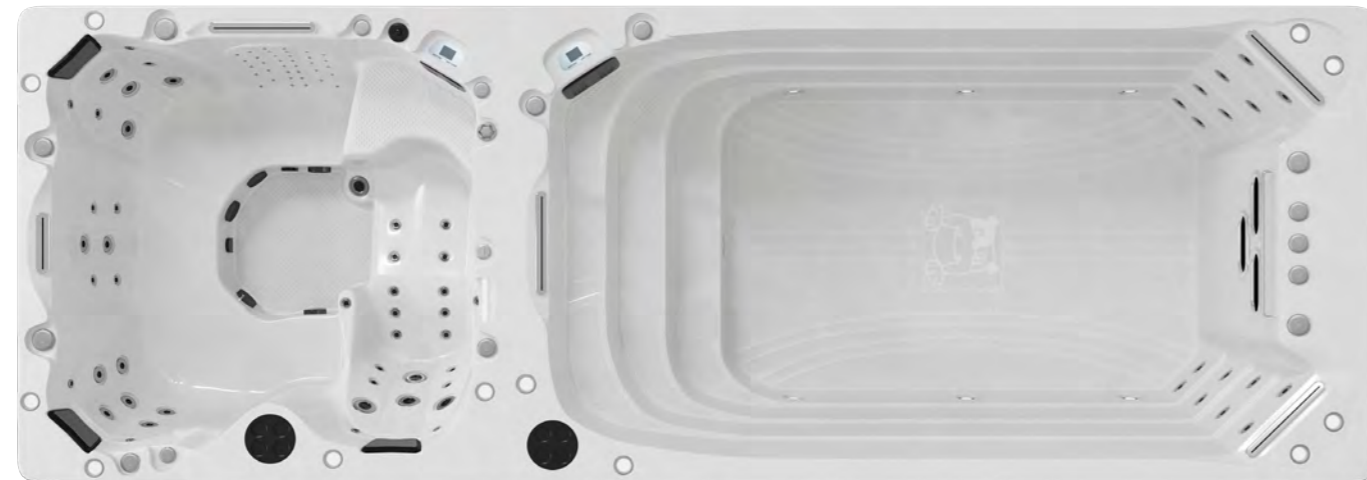

## HOT TUB SPECIFICATION

<b>DIMENSIONS:</b>	225 x 225 x 92CM	<b>WATER CAPACITY:</b>	1,650L
<b>MESSAGE JETS:</b>	97	<b>PUMPS:</b>	3 x 3HP
<b>SEATS:</b>	6 (Inc Lounger)	<b>LIGHTING:</b>	Underwater, Colour Changing

## HIGHLIGHTS

- 3 High Flow River Swim Jets • 2 Hydrotherapy Stand Up Zones
- Exercise Zone • 4 Massage Areas • Pure Zone - Ozone Purification System
- Easy Access Steps and Exercise Area With Non-Slip Design • 3 Waterfalls
- Eco Zone Triple Layer Insulation • Safety Rail • Underwater Lighting
- Levitator Jets - Upstream Bouyancy Swim Technology
- Jet streams at a 45-degree angle from below for a perfect water position
- Highest Quality Control System: Balboa Spa Touch (Touchscreen)
- Fitness Equipment included (Resistance Arm Bands, Row Bars, Adjustable Belted Swim Tether)
- Clear Zone - Easy Clean Commercial Grade Water Filtration System

## FEATURE PACKED AS STANDARD

Immersed Jet Chambers	Steel Reinforced Spa Acrylic
Safe Skimmer	Adjustable Dials
Tactile Therapy	Titanium Heater
Fast Flow Refill Drain	Freeze Protection
High Power LX Pumps	Quick access Gate Valves
Water Diverters	Heat Pump Ready
Swimming Resistance Pole	WiFi Ready
Thermal Sealed Ultra Locking Cover	Stainless Steel Adjustable Jets
Solid Zone™ - ABS Base	Adjustable and Interchangeable Massage Jets
Solid Zone™ - Galvanized Steel Frame	Easy Access Panel for Service and Maintenance

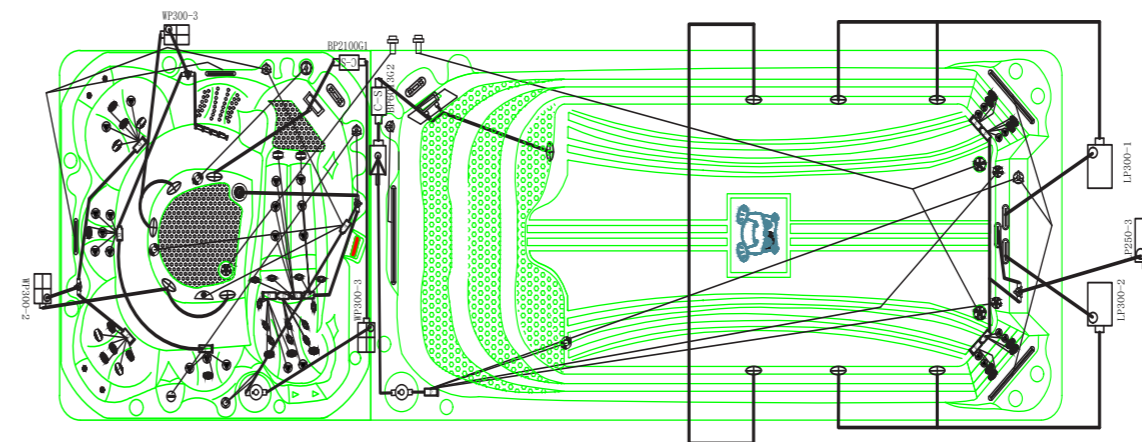

### T500ST + HT SCHEMATIC

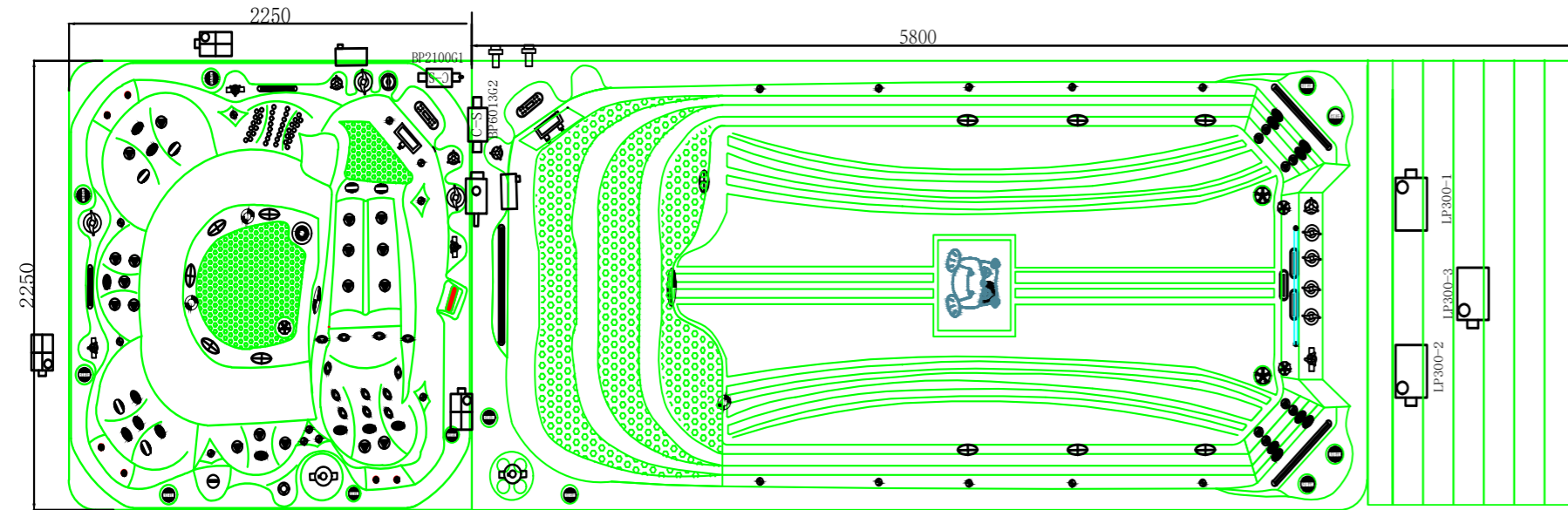
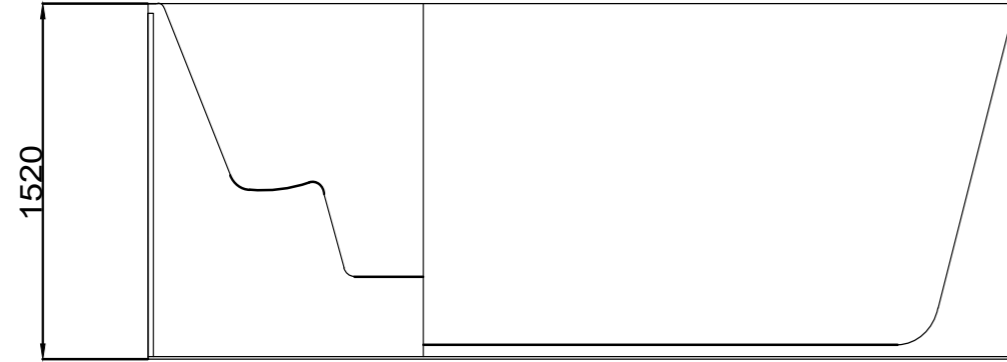

### SHELL COLOURS



SILVER WHITE MARBLE

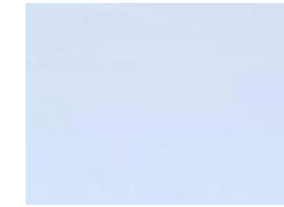

WHITE PEARLESCENT



NICKEL

### CABINET COLOURS



CHARCOAL

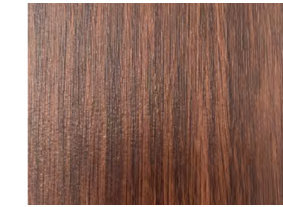

BROWN

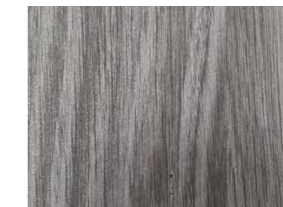

GREY

### COVER COLOURS

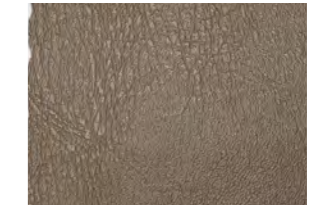

BROWN



GREY



# A BETTER SWIM EXPERIENCE



OPTIMAL SWIM



TRACK YOUR SWIM\*

\*WITH OPTIONAL SMART SWIM WATCH

(\*) only available on the Turbine Swim Spa models.



NATURAL EXPERIENCE



CONVENTIONAL COUNTER FLOW SYSTEM

TURBINE SWIM SYSTEM WITH LEVITATOR JET



## AQUATIC EXERCISE



CURL



KICK



ROW



JOG



STRETCH



SWIM



RUN



WALK



WARWICKSHIRE  
Spa House,  
Watling Street  
Dordon  
Warwickshire CV9 2PZ  
01827 897000



LUTTERWORTH  
Coventry Road  
Lutterworth  
LE17 4JB  
01455 558975



CHESHIRE  
Mobberley Rd  
Knutsford  
Cheshire  
WA16 8JF  
01565 750850



# TAKE A WET TEST

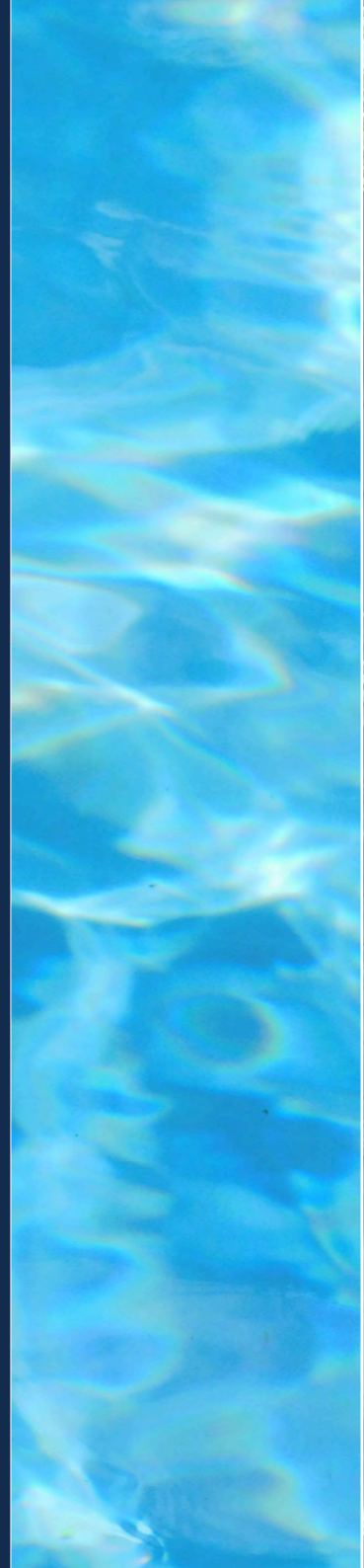



[www.britishhottubs.co.uk](http://www.britishhottubs.co.uk)

Due to continuous improvement programs, British Hot Tubs may make product enhancements and modifications that may not be reflected in the shown content/images. Please see your local Dealership for current specifications.